

AQUARIUS

950BW Boiler Water Controllers

**Microprocessor Control
for Automatic Blowdown
and Chemical Dosage
on Steaming Boilers rated
up to 1600 kPa.**

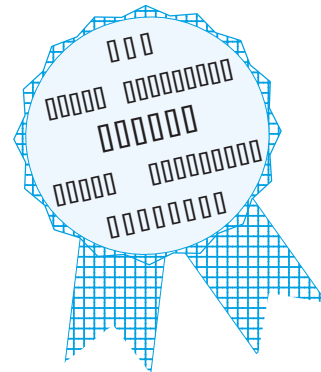

- ✓ Microprocessor Circuitry
- ✓ Automatic Blow Down
- ✓ Auto Chemical Dose on
- ✓ Feed rate or Blowdown Mode
- ✓ Duty Cycle on Dosage Rates
- ✓ Evaporation Rate Proportional Sampling
- ✓ IP65 rated Weatherproof Enclosure

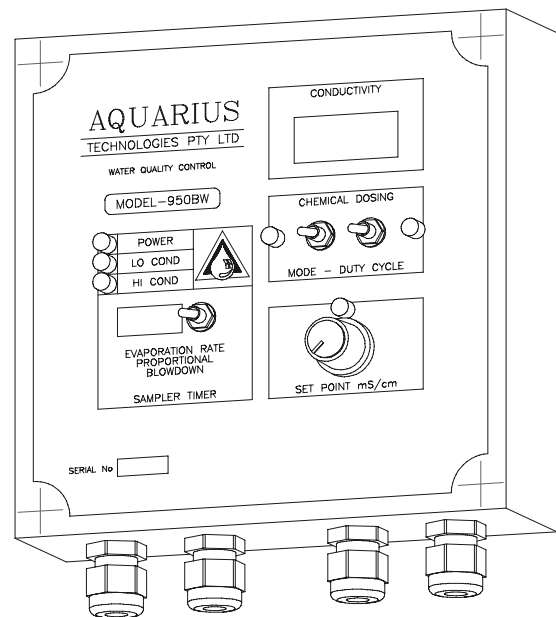

With Options Available for

- ✓ Controller only or with manifolds
- ✓ Manifold & Valves for 1050 kPa.
- ✓ Manifold & Valves for 1600 kPa.

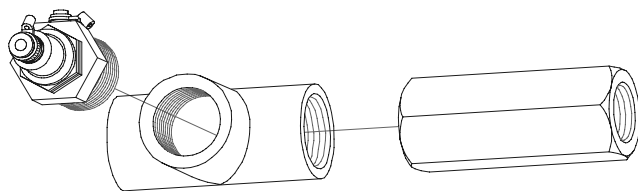

Aquarius 950BW Boiler Controllers

Features and Benefits

1. **"State of the Art" - Microprocessor Control with embedded custom software for control of conductivity or T.D.S. and dosage on Steaming Boilers, with Duty Cycle dosage to allow dosage of neat chemicals direct from container as supplied.**
2. **The controller utilises Evaporation Rate proportional sampling to ensure that the sampling rate is directly proportional to the steam output and thus avoids excess blowdown at low loads unlike its competition.**
3. **A No Volt alarm is designed into the package - High & Low Conductivity alarm facilities are set on Conductivity or T.D.S. levels to provide for an alarm in the case of malfunction.**
4. **The carefully designed manifolds allow for optimum service, safety and ease of operation, whilst allowing for a wide range of blowdown rates of up to 5000 kgs/hr and common pressures ranges of either -up to 1050 kPa. and up to 1600 kPa. working pressures.**
5. **Chemical Dosage can be controlled from the unit, either proportional to feed water rate or proportional to the blowdown rate by simple switch selection. Duty Cycle control on chemical dosage allows for dosage of undiluted Water Treatment chemicals and the smallest dosage pumps.**
6. **Use of a 950BW or (950BW/D unit is mandatory where boilers are unattended and where evaporation rates or feed water conditions may vary. The use of these controllers allows for automatic blowdown with chemical treatment under most conditions.**
7. **Controllers are manufactured to ISO 9001 standards from a water treatment background and designed to meet the requirements of automatic steaming boiler blowdown, with chemical treatment, and other applicable Australian standards.**

Options Available

Model - 950BW/D Controller

Controller with LCD display and conductivity readout in millisiemens - range 0 - 10.00 mS/cm, (= approx. 0 - 5000 ppm or mg/l as T.D.S.) supplied with high temperature probe, orifice & 20 mm Steam Tee as probe holder.

950MAN15 - manifold

- a 15 mm. manifold containing, isolating valves, y - strainer with a drain valve, check valve, and 15 mm steam rated Solenoid Valve **rated for a maximum operating pressure of 1050 Kpa. (150 psi) (10 bar)**

The maximum blowdown rate **with the orifice in the 950MAN15 manifold is approx. 500 kgs./hr.** and this is intended for smaller boiler applications. With the orifice removed, the blowdown rate is approx 2000 kgs/hr

950MAN23 - manifold -

- a 15 mm manifold containing isolating valves, y -strainer, check valve, and 15 mm steam rated Solenoid valve, **allowing for a maximum blowdown rate of approx. 2500 kgs./hr. and rated for maximum operating pressure of 1600 Kpa. (230 psi) (16 bar).** intended for the larger, and higher pressure industrial boiler

CONTROLLER SPECIFICATIONS

ENCLOSURE - Glass filled polycarbonate enclosure with transparent sealed lid giving protection to Class IP65 against water, oil and dust.- 175 mm x 175 mm x 75 mm deep nominal.

OPERATING VOLTAGE - SUPPLY = 220 - 240 Vac, 50 Hz, 10 AMP. **OUTPUTS** = 3 relays, - 1 each for the dose pump, the blowdown solenoid, and the external alarm.

The external alarm relay is wired as a NO VOLT output and fail-safe, i.e. loss of power = an alarm state.

RANGE - 0 - 10,000 uS/cm (0 - 10.0 mS/cm) at 25 °C (approx. 0 - 5000 ppm (mg/l) as T.D.S.)

INDICATOR LEDS - Separate LEDS indicate for power on, dose pump energized, dump solenoid energized, low conductivity and high conductivity.

DIGITAL DISPLAY - When fitted as an optional extra, is 12.5 mm LCD, reading to 10.00 mS/cm (10,000 uS/cm), reads conductivity value only during the blowdown period only and holds this figure during non blowdown periods, to indicate the actual boiler water's true specific conductivity at 25 °C.

CALIBRATION - Via front panel - a screw driver adjusts a trim pot to allow +/- 30% for calibration, and to allow for variations in probe factors and/or caustic alkalinity.

PROBE - Stainless steel electrode embedded in ceramic and fitted to 20 mm N.T.P. bushing for fitting in a 20 mm steam tee - uncompensated for temperature, - the maximum operating pressure rating for probe is in excess of 2000 kPa.

PROBE VOLTAGE - Less than 5.0 Volt of high frequency AC is used to excite the probe and sense the conductivity of the boiler water sample..

Aquarius 950BW Boiler Controllers

950BW/D Controller Package

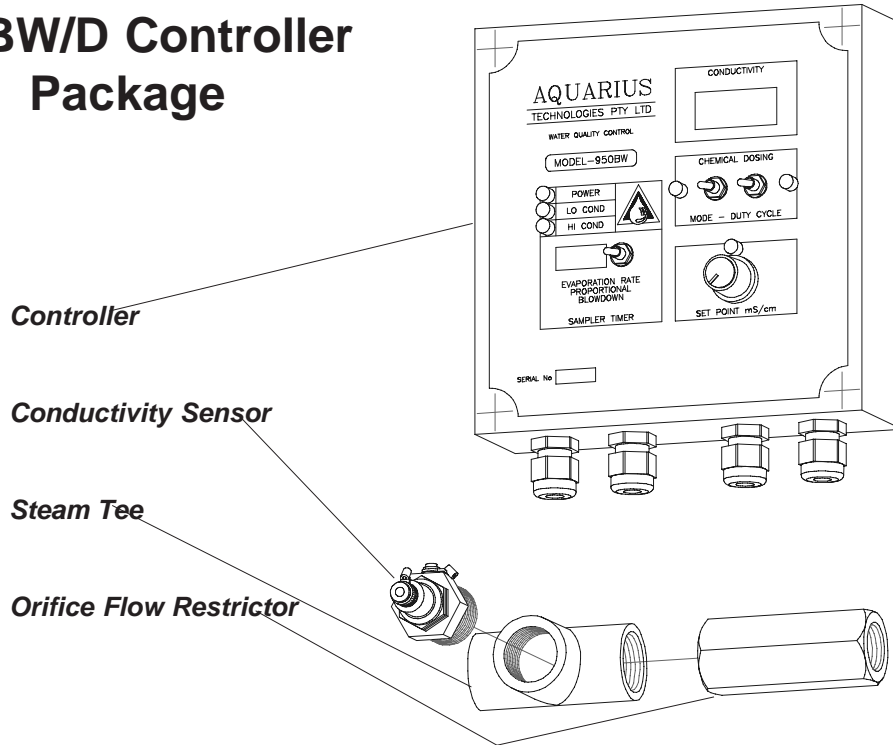

950MAN15 Manifold - Maximum 1050 kPa. Working Pressure

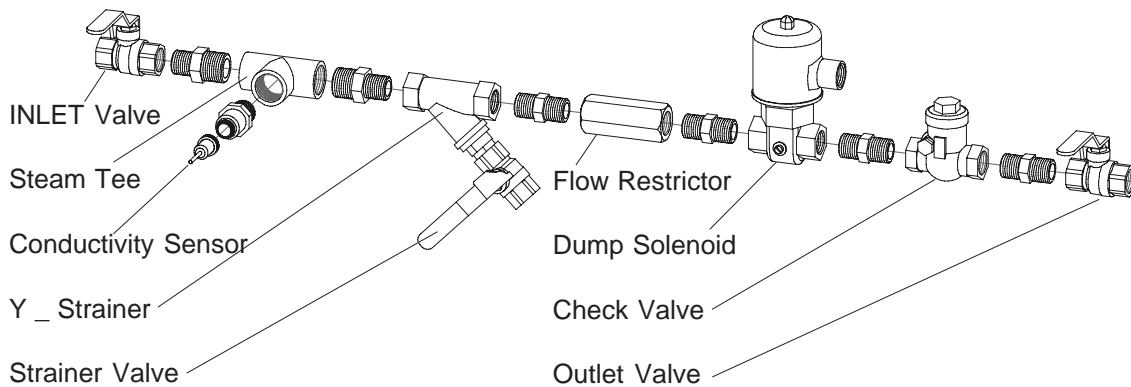

950MAN23 Manifold - Maximum 1600 kPa. Working Pressure

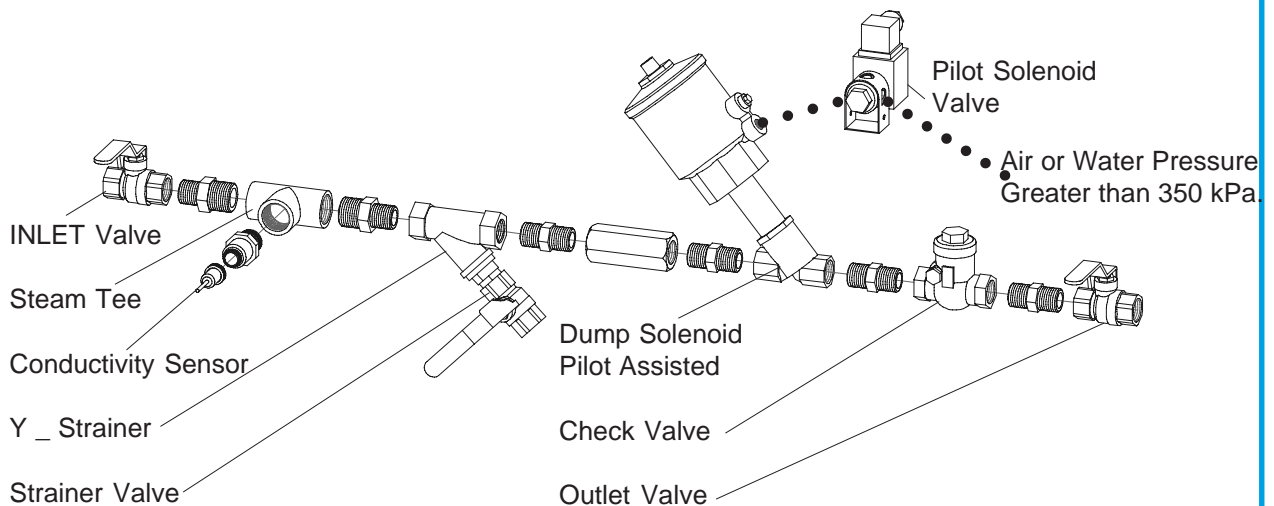

Aquarius 950BW Boiler Controllers

TECHNICAL DESCRIPTION

The **AQUARIUS -- 950BW Boiler Water Treatment Controller**, is the third generation of controllers designed to overcome automatic blowdown problems on boilers with fluctuating steam loads -

The **950BW Series** allows for **Evaporation Rate Proportional Sampling Timing** and reacts as a complete precise and automatic system for control of skimmer blowdown in steaming boilers **up to 1600 Kpa. working pressure, (when using the 950MAN23 Manifold) or 1050 Kpa. working pressure when using the 950MAN15 manifold**, and includes provision for chemical dosage, either automatically with blowdown, or proportional to feed water flow, via a front panel select switch.

By controlling the frequency of the sampling period as a function of feed water flow the 950BW Series provide sampling in proportion to evaporation rate and thus eliminates the problems of excessive blowdown on low load or stand-by conditions - unlike its competition.

The **950BW Series** has been designed to maintain a constant boiler water conductivity level regardless of variations in, evaporation rate, make up water quality, or condensate return.

The **950BW Series Controllers**, contains microprocessor circuitry and special software algorithms to linearise the conductivity scale and provide for:-

A Repeat Cycle Sample Timer - which periodically opens the blowdown solenoid valve for a short sampling period of 10 seconds duration. The conductivity of the water is monitored and fed back to the controller. Should the conductivity be slightly in excess of the set point, the controller will automatically maintain the dump solenoid in the open position until such time as the conductivity has dropped to slightly below the set point. The frequency of sampling is variable via the front panel **SAMPLE TIMER dip switch** to accommodate a wide range of boiler capacities and feed water conditions.

A select switch **Cont - Feed** beside the sample timer allows the sample frequency to operate in **Continuous mode or to be modulated in proportion to Evaporation Rate - Set the Cont - Feed Switch to Feed mode**, and this prevents **excessive blowdown under conditions of low load or stand-by conditions.**

Where load on the boiler fluctuates the ideal setting is **Feed Mode** for the sample timing which in turn allows for **Evaporation Rate Proportional Sample Timing** which allows the blowdown solenoid size and/or orifice to be sized for the Boiler maximum capacity, **and set up once only at the time of installation without any need for change.**

Refer to selection chart later for solenoid sizing, and /or orifice for various boiler maximum capacities as well as settings for **Sample Timer Dip Switch.**

The **950BW** will minimise wasteful blowdown, and is ideal for use on unattended boilers with fluctuating load cycles. It will only sample at a rate proportional to feed water flow rate, and thus will not blowdown due to excessive sampling.

Use of the **950BW** will reduce the possibility of carry over of boiler water into the steam, whilst providing automatic control on T.D.S. levels.

The ideal set up consists of a **950BW** controller and probe with the **950MAN15 -(for operating pressures of less than 1050 Kpa.)** comprising manifold, solenoid blowdown valve, orifice, strainer and isolation valves) for blowdown rates up to 2500 kgs./hr. or **950MAN23 manifold - (for operating pressures of up to 1600 Kpa.)** and for blowdown rates up to 5000 kgs./hr.

For small boilers or where the blowdown rate is less than 500 kgs./hr. it is recommended that the orifice remain in the manifold to restrict the flow rate via the blowdown solenoid.

The correct choice of manifold, solenoid size, and whether to use the orifice in the manifold or not, depends on the boiler operating pressure and the maximum blowdown rate required per hour, which in turn depends on the Boiler Capacity in Kw and on the maximum concentrations of feedwater that can be maintained in the boiler.

After ascertaining the boiler operating pressure, the boiler steaming capacity in Kw and the maximum concentrations which can be maintained in the boiler, consult the 3 charts later in this brochure:-

Chart No 1 - primarily for small boilers operating at less than 1050 Kpa. working pressure, and with blowdown rates of less than 500 kgs per hr - the orifice is used to restrict flow in the 950MAN15 manifold and this set up is recommended for all the white areas of Chart No. 1.

Chart No. 2 has the orifice removed from the 950MAN15 manifold and allows for blowdown rates of up to 2500 kgs./hr., again at operating pressures of less than 1050 Kpa. and this arrangement is recommended for all of the white areas of chart No. 2.

Chart No. 3 - applicable to the 950MAN23 manifold is recommended for operating pressures of up to 1600 Kpa. and blowdown flow rates of up to 5000 kgs./hr. The white areas on chart No. 3 indicate the suitability of the 950MAN23 manifold.

Aquarius 950BW Boiler Controllers

FRONT PANEL FUNCTIONS

OPTIONAL LCD DISPLAY

LCD Display 12.5 mm high reading to 10.00 mS/cm (10,000 uS/cm). on 950BW/D

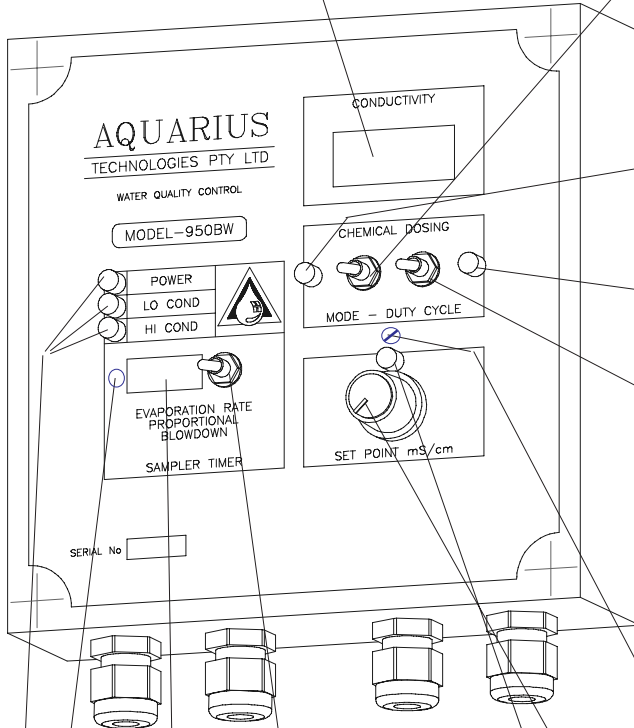

CHEMICAL DOSING

MODE SWITCH

Feed allows Duty Cycle to time up only when **Feed Pump is ON or running**
Blowdown only allows Duty Cycle to time out when **Blowdown Solenoid is energised**

RED LED - ON

Chemical pump relay is energised

RED LED - FLASHING

Duty Cycle Timer is active.

DUTY CYCLE SWITCH

100 = continuous operation
or 100% Duty
20 = allows pump to run **1 min. ON** and **4 mins. OFF or 20% Duty**
5 = allows pump to run **1 min. ON** and **19 mins. OFF or 5% Duty**

RED LED - ON Indicates Power **ON**

RED LED - ON Conductivity is **less** than Set Point - 25%

RED LED - ON Conductivity is **more** than Set Point + 20%

SAMPLE TIMER - Set one of eight switches to **ON** to set delay period between samples at probe. Refer Charts.

LED - on for 2 secs and **off** for 2 secs
 Indicates Sample Timer is timing up

Cont - Feed - SWITCH -

in **Cont** mode allows sample timer to time up on a **Continuous Basis** -

In **Feed** mode timer is only allowed to time up **when the Feed Pump is ON running.**

BLOWDOWN SET POINT

Cal ○

Allows calibration of the sensor after replacement or cleaning.

SET POINT KNOB

Adjust knob to set maximum conductivity for the system, - dial is scaled in millisiemens (5.0 mS = 5000 uS = approx. 2500 ppm T.D.S.)

RED LED - ON

Red Led indicates the Blowdown Solenoid relay is energised.

Aquarius 950BW Boiler Controllers

Installation, Commissioning & Operating Instructions

TABLE OF CONTENTS

Technical Description of the Controller and Functions.....	4
Packages Utilising this Controller and Options.....	2 & 3
Specifications.....	3
Front Panel Functions and Control Features.....	5
Installation Guidelines.....	7
Electrical Wiring Requirements.....	8
Charts for Optimising the 950BW package.....	9
Commissioning and Start-up Procedures.....	10
Care, and Cleaning and Calibration of Sensors.....	10
Routine Maintenance.....	10
Recommended Accessories and Spare Parts.....	10
Manufacturer's Product Warranty Policy.....	11
Equipment Owners - Commissioning & Warranty Validation Report	12

Aquarius 950BW Boiler Controllers

INSTALLATION

Piping & Plumbing

INSTALLATION OF THE PROBE, ISOLATING VALVES, AND THE DUMP SOLENOID MUST COMPLY WITH RELEVANT REGULATIONS CONCERNING PRESSURE VESSELS AND STEAMING BOILERS IN PARTICULAR, AND SHOULD BE IN ACCORDANCE WITH ANY REQUIREMENTS OF YOUR LOCAL BOILER OR D.O.S. INSPECTOR.

Installation is intended for steaming boilers already fitted with provision for a skimmer blowdown, with an isolating valve in the line adjacent to the boiler, the probe should be installed in the 20 mm N.T.P. steam tee provided, with the probe pointing horizontally in toward the boiler, **or preferably with the 950MAN15 or 950MAN23 manifolds** and directed to the blowdown tank or flash steam tank, - refer to the diagram below.

SUGGESTED INSTALLATION SCHEMATIC

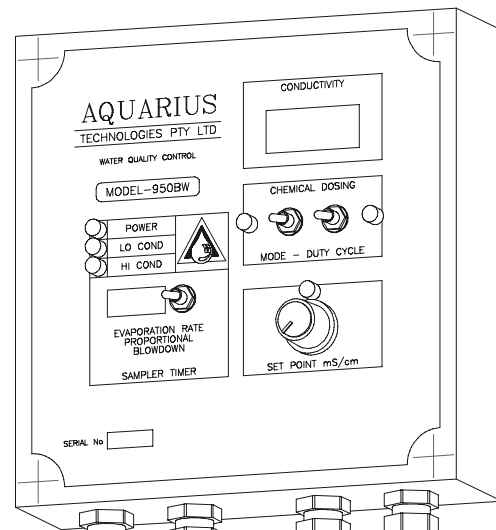

Mains 220 -240 Vac
Power Supply

Control From
ON/OFF type
Feed Pump

Inlet from Boiler
Skimmer Take Off
or Bypass on the main
Blowdown Valve

Dump Solenoid
Steam Rated

Y - Strainer with
Sample Valve

Inlet Isolation
Valve

Steam Tee

Orifice or
Flow Restrictor
Holder

Check Valve
or Non Return

Outlet Isolation
Valve

Conductivity Sensor
P/No. PRBW5

TO Blowdown
Tank or to
Flash Vessel

950MAN15 manifold - rated to 1050 kPa.

Aquarius 950BW Boiler Controllers

ELECTRICAL WIRING

The 950BW controller enclosure should be wall mounted, away from the boiler to minimise high temperature effects, preferably with the boiler electrical controls, and supplied with 220 - 250 Vac. mains supply via a 10 amp isolating fuse, and from the boiler control panel such that the controller is automatically energized when boiler is on, and de-energised when the boiler is off.

Removal of four (4) self tappers, allow the front panel to be removed to expose marked terminals on the printed circuit board. The 220 - 250 volt mains wiring for supply, solenoids, dosage pumps or external alarm, should be separated from the low voltage probe wiring or alarm wiring, and enter controller via separate glands or conduit entries. Power from the boiler control panel should be fed directly to the Electromagnetic Interference filter prior to being connected to the printed circuit board.

To allow the Feed Mode switch to modulate the sample frequency, it is necessary to provide a controlled 220 - 250 volt Active source from the Feed pump contactor. This is done by running a wire from the A1 terminal (which is connected to unfiltered 240Vac power) to one side of a voltage free contactor which is energised whenever the boiler feed pump is operating. Connect the other side of the contactor back to the terminal marked Feed on the PCB terminals. The wiring schematic below illustrates the connections required.

The wiring to the probe should be in mains quality twin cable wiring, of minimum length, of low resistance and capable of withstanding the temperatures in the boiler room. Where an alarm is being used and is derived from 240Vac, it is preferred to run this power from the unfiltered mains input.

ELECTRICAL WIRING SCHEMATIC

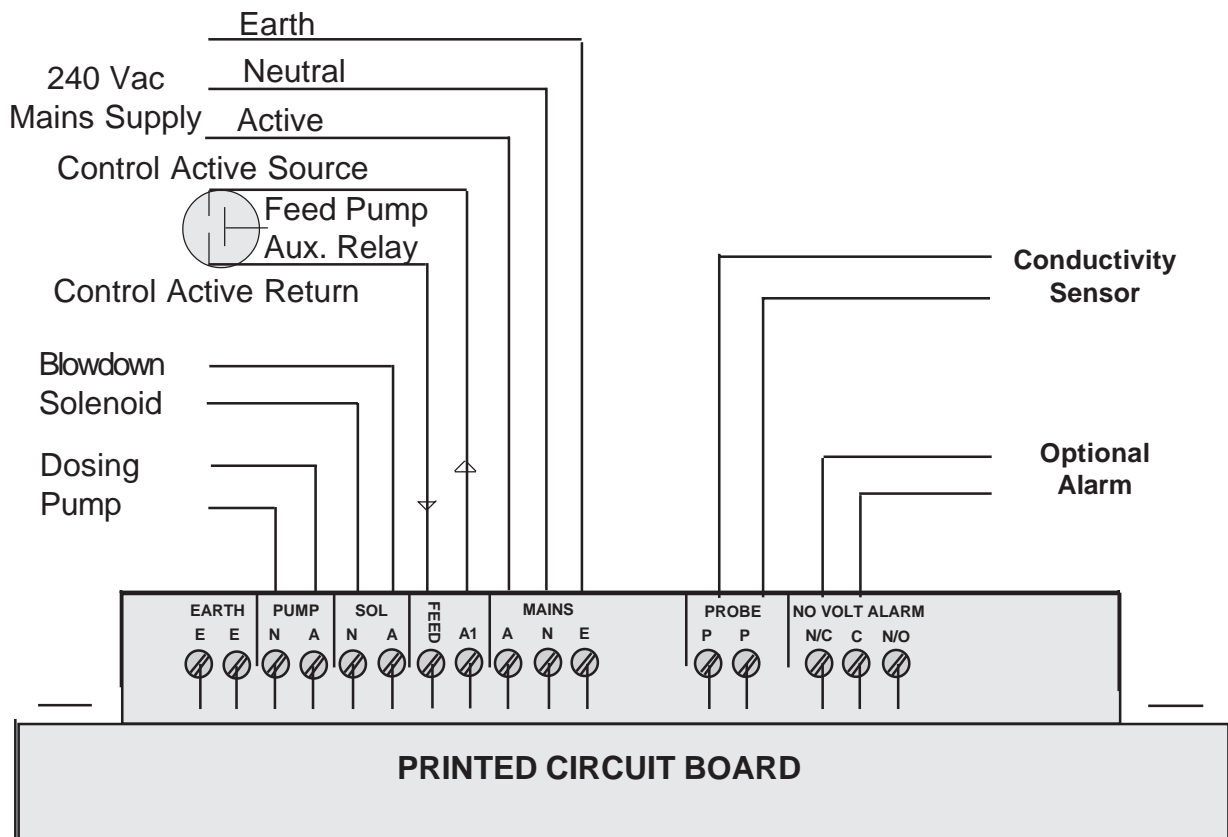

Aquarius 950BW Boiler Controllers

Determination of Optimum Installation Package

1. Ascertain the Boiler Steaming Capacity in Kilowatts, or in kgs./hr. Evaporation Rate.
2. Ascertain the Maximum Concentrations of feedwater that can be maintained in the boiler.
3. Ascertain the Boiler Operating Pressure and ensure the manifold is rated accordingly
4. Using the charts below follow a line from the Boiler Capacity across to meet the line down from maximum concentrations - If this intersection fall on a white square with a number this manifold should provide sufficient flow for maximum blowdown on this installation - if it falls on a black square go to the next chart. **If the Boiler operating pressure exceeds 1050 Kpa. (150 psi) (10.5 bar) use 950MAN23 manifold and Chart No. 3 for pressures of up to 1600 kPa. (230 psi) (16.0 bar)**

CHART No. 1	Boiler Capacity kW.	Evaporation Rate Max. kgs/hr	Maximum Concentrations of Boiler Feedwater							
			6	7.5	10	15	20	30	40	50
			Settings on dipswitch with 950MAN15 manifold, orifice = approx 12 lts/min							
Utilising the 950MAN15 manifold with the ORIFICE FITTED	50	80	6	6	7	8	8	All ON	All ON	All ON
	100	160	5	6	6	7	7	8	8	8
	150	240	5	5	6	7	7	7	8	8
	200	319	4	5	5	6	7	7	7	8
	250	399	4	4	5	6	6	7	7	7
	300	479	3	4	4	5	6	7	7	7
	400	639	3	3	4	5	5	6	6	7
	500	799	2	3	3	4	5	5	5	6
	600	958	N/A	2	3	4	4	5	5	5
	1000	1597		N/A	2	3	4	4	4	5
	1250	1996			N/A	3	3	4	4	5
	1500	2395				2	3	3	4	4
	2000	3194				N/A	2	3	3	4
	2500	3992					N/A	2	3	3
	3000	4791						N/A	2	2
	4000	6388							2	2
5000	7985							N/A	N/A	
6000	9582									

CHART No. 2	Boiler Capacity kW.	Evaporation Rate Max. kgs/hr	Maximum Concentrations of Boiler Feedwater							
			6	7.5	10	15	20	30	40	50
			Settings on dipswitch with 950MAN15 manifold, NO orifice = approx 40 lts/min							
Utilising the 950MAN15 manifold with the ORIFICE REMOVED	50	80								
	100	160								
	150	240	7	7	8					
	200	319	7	7	7	8				
	250	399	6	7	7	8	8			
	300	479	6	6	6	7	8			
	400	639	6	6	6	7	7	8		
	500	799	5	6	6	7	7	8	8	
	600	958	5	5	6	6	7	8	8	8
	1000	1597	4	5	5	5	6	7	7	8
	1250	1996	4	4	5	5	6	6	7	7
	1500	2395	3	4	4	5	6	6	7	7
	2000	3194	3	3	4	4	5	6	6	7
	2500	3992	2	3	4	4	5	5	6	6
	3000	4791	2	3	3	4	4	5	6	6
	4000	6388	1	2	3	3	4	5	5	5
5000	7985	1	1	2	3	4	4	5	5	
6000	9582	1	1	2	3	3	4	5	5	

CHART No. 3	Boiler Capacity kW.	Evaporation Rate Max. kgs/hr	Maximum Concentrations of Boiler Feedwater							
			6	7.5	10	15	20	30	40	50
			Settings on dipswitch with 950MAN23 manifold = approx 80 lts/min							
Utilising the 950MAN23 manifold	150	240	8	8						
	200	319	8	8	8					
	250	399	7	8	8					
	300	479	7	7	7	8				
	400	639	7	7	7	8	8			
	500	799	6	7	7	8	8			
	600	958	6	6	7	7	8	8		
	1000	1597	5	6	6	6	7	8	8	
	1250	1996	5	5	6	6	7	7	8	8
	1500	2395	4	5	5	6	7	7	8	8
	2000	3194	4	4	5	5	6	7	7	8
	2500	3992	3	4	5	5	6	6	7	7
	3000	4791	3	4	4	5	5	6	7	7
	4000	6388	2	3	4	4	5	6	6	6
	5000	7985	2	2	3	4	5	5	6	6
	6000	9582	2	2	3	3	4	5	5	6
10000	15970	1	1	1	2	3	4	5	5	
20000	31940		1	1	1	2	4	5	5	

Aquarius 950BW Boiler Controllers

Commissioning of 950BW controllers

1. Visually check that the installation is complete, and the pressure rating of all the equipment installed is in excess of the boiler rated working pressure.

2. Open the two manifold Isolation Valves and check that the manifold is leak free, then power up the controller electrically.

3. Turn the controller Set Point Knob to Zero position and allow the solenoid to blowdown for 60 secs. to allow for boiler water operating temperatures, and true boiler water conductivity at the probe.

4. Sample the boiler water using an accurate, temperature compensated, conductivity meter either as the unneutralised Specific Conductivity as mS/cm or as unneutralised T.D.S. in ppm.

5. Calibrate the Display and Set Point either from Specific Conductivity in 4. above or use T.D.S ppm x 0.002 = Specific Conductivity in mS/cm (millisiemens/cm)

6. If **the orifice is installed in the manifold refer to Chart No 1** - orifice fitted, and follow Boiler Capacity across to meet concentrations to obtain optimum Dip Switch setting for Evaporation Rate Proportional Sampling, and set the **Sample Timer Dip Switch** to this number.

7. If **orifice is removed use Chart No. 2** and set Dip Switch as in 6 above

8. If **950MAN23 manifold is in use Chart No. 3** and set Dip Switch as in 6. above

9. Set **Cont-Feed** switch to **Feed** to allow for sample timing in proportion to feed water flow rate and then set the chemical dosing parameters.

Boiler conductivity controllers such as the **Aquarius Model 950BW** series actually measure the specific conductivity (or resistivity) of the boiler water (including the NaOH alkalinity) **and the unit should be calibrated and set up based on the conductivity value of a non neutralised sample of boiler water.(i.e. including the conductivity from the NaOH alkalinity present)**

However a neutralised sample is used for analysis reporting when T.D.S. is reported, e.g. 3000 ppm. T.D.S. as such = 4000 μ S/cm (using μ S/cm x 0.75) when neutralised, **and approx. 6000 μ S/cm non neutralised (assuming 300 ppm. of NaOH alkalinity in the boiler water)**

Probe failure or malfunction

The probe or sensor can be removed for cleaning or replacement, **EITHER BY OR UNDER THE SUPERVISION OF TRAINED, LICENSED BOILER OPERATORS**, — providing the inlet isolating valve holds tight, and that this is carefully checked before attempting to remove the probe.

Should the manifold Inlet isolating valve not hold, DO NOT ATTEMPT TO REMOVE PROBE, until the boiler has been fully depressurised, but recalculate the blowdown rate required and reset the Sample Timer to provide the blowdown required from the formulae later in the instructions.

Please advise boiler personnel that the manual blowdown should be activated for at least 30 seconds per 8 hour shift, even when 950BW Controller is in use, to remove mud/debris from the boiler bottom blowdown.

Removal of the Orifice from the Holder

The orifice is screw installed in the orifice holder as indicated in the diagram of the 950MAN15 manifold, removal of the orifice holder allows the actual orifice to be removed by unscrewing and with drawing with an Allen key.

Routine Maintenance

The controller operation should be checked and verified at least monthly, and calibrated as necessary, to maintain best accuracy and control of the boiler blowdown and chemical additions.

This operation can be easily carried out by your water treatment specialist on his routine service visits.

Recommended Spare Parts

1. Conductivity Sensor - Part No. PRBW5
2. Solenoid - 1050 kPa. - Part No. STSOL15
3. Solenoid - 1600 kPa. - Part No. STSOL23
4. Pilot Solenoid - Part No. STPILOT

Recommended Assessories

1. Portable Conductivity Meter. e.g HI8733
2. Conductivity Std. Solution - 2764 μ S/cm - 500 mls.
3. Water Treatment Test Kit for full boiler water analysis.

Aquarius 950BW Boiler Controllers

MANUFACTURER'S PRODUCT WARRANTY

AQUARIUS TECHNOLOGIES PTY. LTD. manufactures a range of equipment under a Quality Assurance system to ISO9001:1994 standards and warrants equipment of its manufacture to be free of defects in material or workmanship.

Liability under this policy extends for 12 months from the date of installation, or 24 months from the date of shipment from our factory, whichever ever occurs first. The manufacturer's liability is limited to repair or replacement of any failed equipment or part of, which is proven to be defective in material or workmanship upon the manufacturer's examination.

This warranty does not include removal or installation costs and in no event shall the manufacturer's liability exceed its selling price of such equipment or part.

Aquarius Technologies Pty Ltd. disclaims all liability for damage to its products through improper installation, maintenance, use or attempts to operate such products beyond their functional capacity, intentionally or otherwise, or any unauthorised repair.

Aquarius Technologies Pty Ltd. will not be responsible for any consequential or other damages, injuries, or expense incurred through use of its products.

This warranty is in lieu of any other warranty, either expressed or implied. Aquarius Technologies Pty Ltd. make no warranty of fitness or merchantability. No agent of ours is authorised to provide any warranty other than above.

This warranty does not exclude any condition or warranty implied by the Trade Practices Act 1974 or separate State Laws in Australia and is in addition to any other right that the original purchaser or any subsequent purchaser may have under Australian law.

Should a unit fail to function normally, please contact our Customer Service Department by phone or fax quoting, Model Number, and Serial Number, for initial discussion of the problems encountered, and if it is necessary to return the item to the factory, a Return Authorisation number will be given to facilitate return, and repair or replacement of the item.

The Item for return should be carefully packaged to prevent any damage in transit, contain the Return Authorisation identification number, customer identification, and return delivery details, and the freight prepaid to our factory. If in the opinion of our factory, after examination, the failure was due to materials or workmanship, repair or replacement will be made with out charge for parts, labour and return freight. A reasonable service charge will be made for diagnosis and/or repairs due to normal wear, abuse, tampering or damage in transit.

AQUARIUS TECHNOLOGIES PTY Ltd. reserve the right to continue development and improvement of the entire range of our equipment, and therefore minor changes may occur due to these improvements and the continuing development.

Aquarius 950BW Boiler Controllers

Aquarius Technologies Pty Ltd Commissioning & Warranty Validation Report

This form should be completed by the Equipment OWNER ,
promptly after installation & commissioning
duly signed and faxed to Aquarius on (07) 3274 4736
to enable the equipment installation date and details
to be logged to our confidential Warranty Database
and to validate your 12 months warranty registration.

Please print all details except for signatures

Model :- **Serial No.**

The above equipment was satisfactorily commissioned for :-

Equipment Owner - Company Name

Address.....

State **Date of Installation**

by

Commissioning - Company Name.....

Address.....

State

Technician Name **Signature**.....

Signed for and on behalf of the Equipment OWNER

Name.....

Signature.....

Date.....

Thank you for your very valuable support, purchase and installation

Aquarius Technologies Pty Ltd