

**Factory Address**

18 Chambers Road  
Woodford, Queensland  
Australia, 4514

**Telephone:** +61 7 5422 9944

**Fax:** +61 7 5422 9903

**Email:** [sales@australianpoolequipment.com.au](mailto:sales@australianpoolequipment.com.au)



pristine  
auto self cleaning

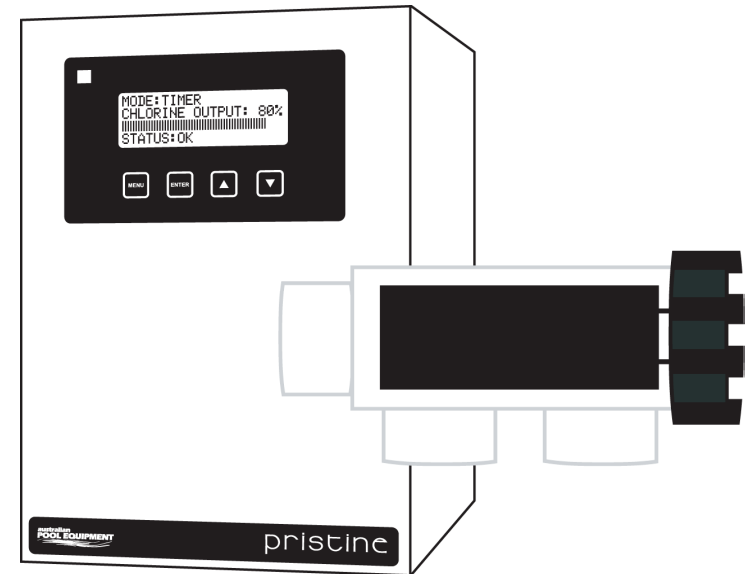

**OWNER'S MANUAL**

[www.australianpoolequipment.com.au](http://www.australianpoolequipment.com.au)

Please read this manual carefully before operating your pool chlorinator and cell. Retain for future reference.

## CELL WIRING DIAGRAM

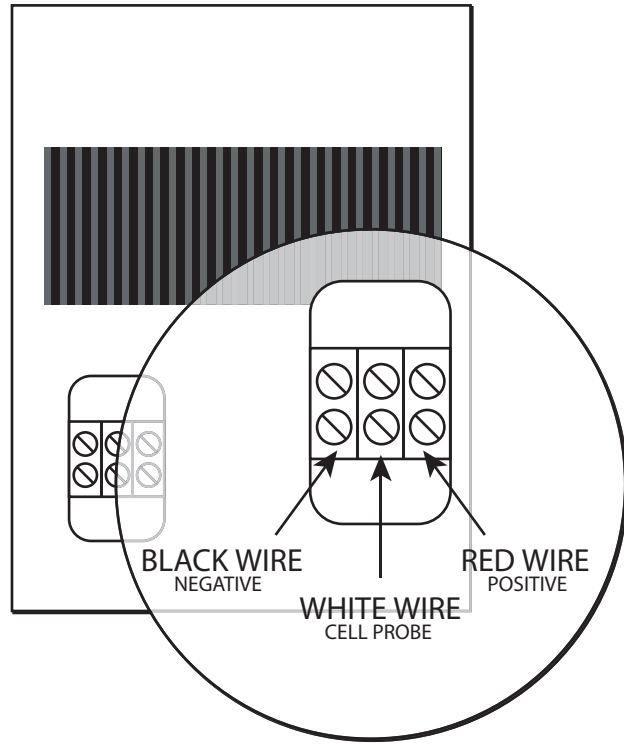

### BLACK (NEGATIVE)

Connect the black cable from the cell to the **BLACK** on the junction box (left side connection when looking at the black)

### WHITE (CELL PROBE)

Connect the white cable from the cell to the **WHITE** on the junction box (middle connection when looking at the back)

### RED (POSITIVE)

Connect the red cable from the cell to the **RED** on the junction box (right side connection when looking at the back)

## SPECIFICATION TABLE

MODEL NUMBER	PRI-15	PRI-20	PRI-25	PRI-30	PRI-35	PRI-50	PRI-100
VOLTAGE AC INPUT	220/240	220/240	220/240	220/240	220/240	220/240	220/240
AMPS AC INPUT	0.5A	0.6A	0.7A	1.1A	1.1A	1.35A	1.95A
VOLTAGE DC OUTPUT	7V	7V	7V	7V	7V	7V	9V
AMPS DC OUTPUT	8.5A	11A	13.5A	15.7A	18.5A	26.6A	26.6A
CHLORINE GR/HR	17	22	27.5	33	38	57	110
POWER WATTS	86	124	140	153	185	265	433
FRQUENCY (Hz)	50/60	50/60	50/60	50/60	50/60	50/60	50/60
WEIGHT (Kg)	8.6	9.5	9.8	10.2	10.5	11.5	13.5
DIMENSION (cm)	28 H 18 W 19 D	28 H 18 W 19 D	28 H 18 W 19 D	28 H 18 W 19 D	28 H 18 W 19 D	28 H 18 W 19 D	28 H 18 W 19 D

**WARRANTY FORM**

**NAME OF PURCHASER:** \_\_\_\_\_

**ADDRESS:** \_\_\_\_\_

**PURCHASED FROM:** \_\_\_\_\_

**DATE OF PURCHASE:** \_\_\_\_\_

**MODEL:** \_\_\_\_\_

**SERIAL NUMBERS**

**CONTROL PANEL:** \_\_\_\_\_

**CELL:** \_\_\_\_\_

**IMPORTANT:** This section must be filled out at time of purchase to render warranty effective

**KEEP IN A SAFE PLACE FOR YOUR REFERENCE**

**QUICK START GUIDE**

1. Connect cell lead to terminal block red-red, white-white, black-black
2. Connect pump to chlorinator pump outlet
3. Connect chlorinator to mains power
4. Press **[ENTER]** button to turn chlorinator **ON/OFF/Timer** mode
5. Press **[▲]** to increase chlorine output
6. Press **[▼]** to decrease chlorine output
7. Press **[MENU]** button, select **TIMER SETTINGS** to set chlorinating times
8. Press **[MENU]** button, select **CLOCK** to set time of day
9. Press **[MENU]** button to set all other parameters

## CONTENTS

CELL WIRING DIAGRAM	1
QUICK START GUIDE	2
CONTENTS	3
CHLORINATOR OWNER	4
PRISTINE OVERVIEW	5
INSTALLATION	6
IDEAL WATER QUALITY	7
OPERATION	7
MAIN OPERATING SCREEN	8
CHANGING MODES	8
SETTING THE CHLORINE OUTPUT LEVEL	9
SETTING THE TIMER	10
PUMP PROTECTION	11
CELL CLEANING	12
SETTING THE TIME	13
ADJUSTING THE LCD CONTRAST	13
SYSTEM INFO	14
HOW DOES THE SELF CLEANING PRISTINE CELL WORK?	15
HOW DO I MAINTAIN THE CELL?	15
HELPFULL HINTS	16
TROUBLE SHOOTING	17
GENERAL OPERATING AND POOL MAINTENANCE	18-19
WARRANTY	20
WARRANTY FORM	21
CHLORINATOR SPECIFICATIONS	22

## WARRANTY

Your PRISTINE Chlorinator carries the following warranty should a fault occur due to faulty materials or manufacture.

AUSTRALIAN POOL EQUIPMENT warrants the original purchaser of the control panel and cell electrode, whether personal or commercial use, for a period of three years or 7000 hours, (whichever comes first), from the date of purchase should the purchaser disclose that this particular equipment failed due to faulty materials or manufacture.

The equipment under warranty claim must be returned to AUSTRALIAN POOL EQUIPMENT for repair or replacement. Costs associated with freight and incidental charges resulting from goods being returned to AUSTRALIAN POOL EQUIPMENT are at the customer's expense and AUSTRALIAN POOL EQUIPMENT will cover the cost of returning the equipment to the customer.

The warranty does not apply to any material supplied or workmanship performed by others in the process of installing the equipment. Nor does it apply if the equipment has been repaired or altered by any one other than AUSTRALIAN POOL EQUIPMENT personnel or an AUSTRALIAN POOL EQUIPMENT Representative. This warranty does not apply if the equipment has been subject to misuse or misapplication.

The warranty applies to materials and manufacture only. This warranty does not cover an act of god, i.e. storm and tempest, lightning strike, floods, tsunami, earthquake etc. AUSTRALIAN POOL EQUIPMENT or its agent will replace at no charge, all parts, which show faulty materials or manufacture faults. The foregoing constitutes the entire liability of AUSTRALIAN POOL EQUIPMENT to the original owner of the equipment. There are no other warranties, expressed or implied, including but not limited to the implied warranties of merchantability or fitness for a particular purpose other than those contained herein.

In no event will AUSTRALIAN POOL EQUIPMENT be liable to the original or subsequent owners either directly or as an indemnitor, or any direct, incidental or consequential loss, damage or economic loss, damage or injury to any person or property arising out of or relating to the equipment or any parts supplied in the equipment, except as expressly stated herein. No other person, or company or organisation is authorised to make any warranties, guarantees or representations, or allowed to allow any exceptions to this warranty, or assume any other liability or obligation on behalf of AUSTRALIAN POOL EQUIPMENT in connection with the equipment. This warranty shall not extend to any expenditure incurred.

### My eyes are burning when I swim and I can smell the chlorine strongly.

If your eyes are burning then there is too much chlorine in the pool. You may be running the chlorinator for too long or your water is out of balance.

Check water balance and adjust as necessary. Possibly reduce the number of hours you chlorinate the pool (colder months generally require less chlorination than warmer months).

1. Cell
2. Cell O'ring
3. Cell Housing
4. Cell Nut
5. Chassis
6. Front Panel
7. Lid
8. Mounting Bracket
9. Display Label
10. Brand Label
11. J-Box
12. Pump outlet
13. Transformer
14. Display PCB
15. Power PCB Assembly
16. HVAC PCB
17. Fuse
18. Display Cable
19. Relay cable
20. Mains cable

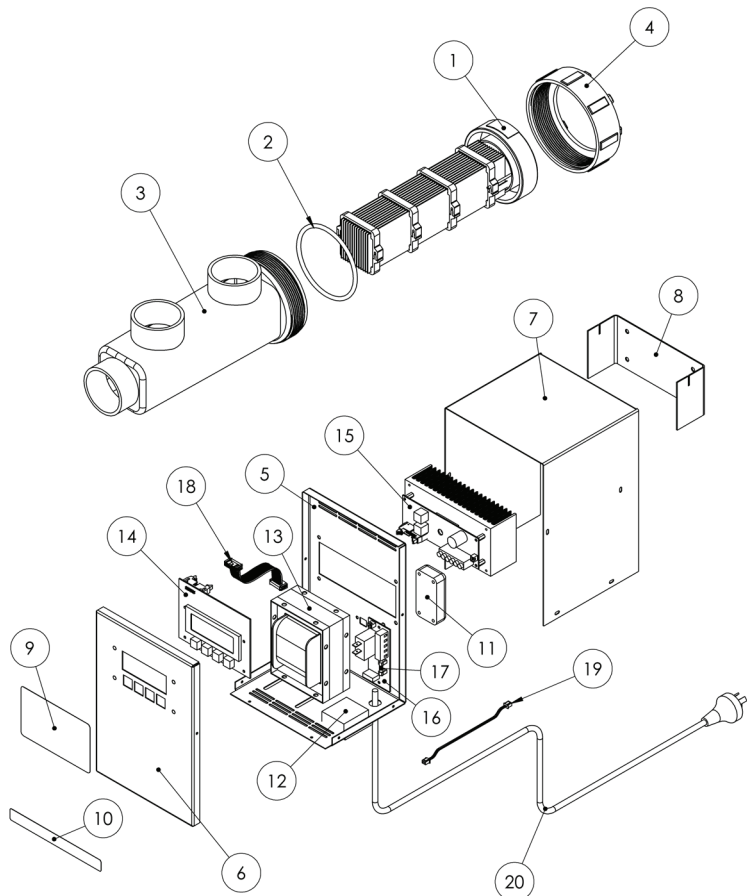

### CHLORINATOR OWNER

The Pristine chlorinator unit is designed to be hung on a wall using the included bracket, between 1 and 1.5 meters above the ground.

The casing is designed with ventilation slots in the bottom to allow cool air to flow up through the case and out the upper rear ventilation slots. The casing and heatsink situated to the rear of the unit can become HOT.

Make sure that garden sprinkler systems do not spray directly into, or on to 220/240volt AC electrical appliances.

Saltwater chlorination is achieved by the electrolysis of brine, which creates both chlorine and sodium hydroxide (caustic soda). Sodium hydroxide has the effect of raising the pH level (increases alkalinity).

Check pH once weekly.

#### IMPORTANT

For the Pristine chlorinator to work efficiently, the pool water should be in optimum condition (balance).

#### pH: 7.4-7.6

Under 6.8 and over 8.0, chlorine production is less effective.

#### Total alkalinity: 120ppm.

Below 80ppm is corrosive, above 150ppm is alkaline and at much higher levels, slimy and slippery.

#### Hardness: 200 - 250ppm

When hardness is too high, it forms scale. When hardness is too low, it becomes corrosive, and etches (eats the surface) concrete pools, or the grout in tile pools.

#### Stabiliser

Stabiliser is essential in helping to preserve the chlorine produced in the water. Without stabiliser, the sun's UV rays will rapidly deplete the chlorine, regardless of the duration or power level the chlorinator is run at.

#### Salt: 6000ppm (6 grams per litre)

In order for the Pristine chlorinator unit to produce 100% of its rated chlorine output, a salt concentration of 6000ppm (6 grams per litre) is required.

When using a pool cleaner, the display may sometimes indicate reduced or fluctuation chlorine output levels. This is due to the presence of air bubbles in the electrolytic cell and is normal. Even when a cleaner is not used, a small amount of output fluctuation can be expected due to small changes in the mains voltage to your home.

Salt concentrations in excess of 7200ppm (7.2 grams per litre) can cause the chlorinator to become overloaded. If the STATUS indicates HIGH SALT reduce the Chlorine Output and add water.

In the event of an OVERLOAD condition occurring, the chlorinator will cease operation for one minute and automatically reduce the output power by 1%. It will then resume operation at this reduced power setting. If an OVERLOAD condition is encountered once again, the above cycle will repeat until the output power is reduced to a level which no longer causes an OVERLOAD condition to exist, even though the salt concentration may be exceedingly high.

Ensure that you check the salt concentration of your water regularly. If the salt concentration is over 7200ppm (7.2 grams per litre) it is advisable that you dilute with the addition of water.

## PRISTINE OVERVIEW

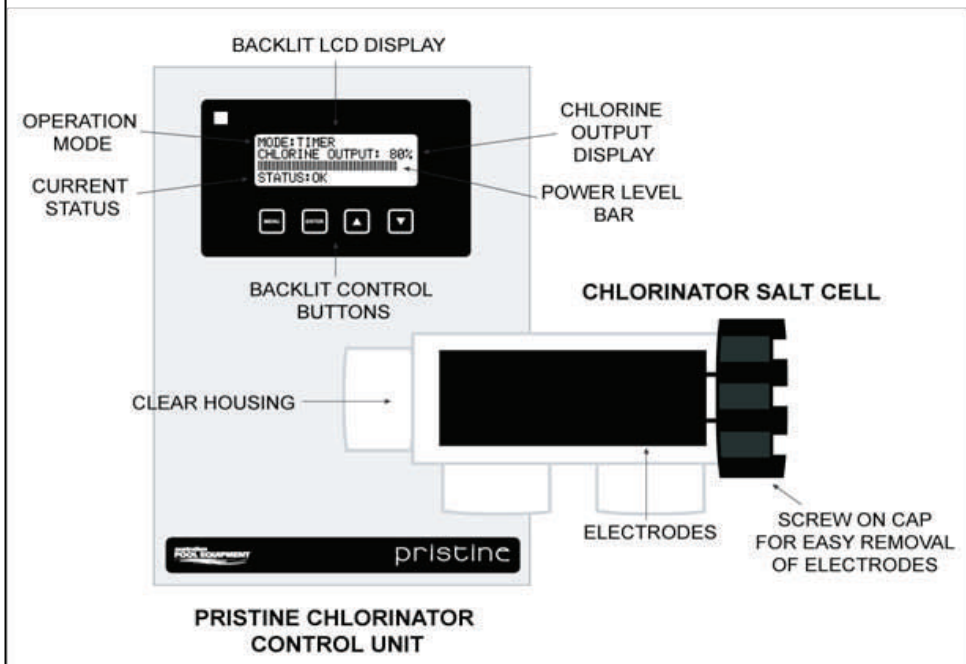

## GENERAL OPERATING AND POOL MAINTENANCE

### How long should I run the Pristine Chlorinator each day?

During the warmer months of the year, the general running time is between six (6) and eight (8) hours a day. Set your Chlorine Output to suit your particular pool and current climate.

During the cooler months of the year, the general running time is between four (4) and six (6) hours a day. Set your Chlorine Output to suit your particular pool and current climate.

Note: This is general advice as each pool is different. Climate, salt levels, water temperature, water balance and pool usage can all affect the chlorine levels in your pool.

### How do I test my pool water?

When testing your pool water you should always start with a pH level test. Adjust pH levels the day before taking any other tests such as Water Hardness, Alkalinity, Chlorine Levels, etc...

### My water appears murky and cloudy. What can I do?

Water can become cloudy from Algae, high hardness levels, infrequent backwashing, inefficient or clogged filter, improper pH levels, deposited calcium compounds and high solids content.

Inspect your filter to ensure it is not clogged, ensure your running time is sufficient, check your pH levels and adjust as necessary to maintain a consistent 1.0 - 1.5ppm chlorine level and now check your total water balance.

### I have green cloudy water and black spots on the pool walls. What can I do?

Algae can be caused due to lack of chlorine.

Check salt and pH levels and adjust as necessary. Select the SUPER CHLORINATE mode from the MODE SELECT menu. Brush any clinging algae spots with a pool brush and routinely check pH levels and maintain a consistent 1.0 - 1.5ppm chlorine level.

## TROUBLE SHOOTING

### The STATUS is displaying 'LOW SALT', what should I do?

The recommended salt level for the Pristine chlorinator to function properly is 6000ppm. If your salt level is under this value or the water is extremely cold, the chlorinator STATUS DISPLAY may indicate LOW SALT.

When adding salt to bring the level up to 6000ppm. ADD IT SLOWLY never more than one bag at a time. Allow time for the salt to dissolve before adding another bag.

Your local Pool Shop can test a sample of your pool water for salt levels.

### The STATUS is displaying 'HIGH SALT', what should I do?

The maximum salt level for the Pristine chlorinator is 7200ppm. If your salt level exceeds this, or if the water temperature is exceedingly high the chlorinator STATUS DISPLAY may indicate HIGH SALT. If the salt level is very high the chlorinator will cease operating momentarily and will attempt operation at a lower power setting. This feature is especially helpful if you are away, as the chlorinator will continue operation at a reduced output rather than shutting down altogether.

HOWEVER: If you are alerted to the fact that the chlorinator is warning HIGH SALT levels it is recommended that you switch off the chlorinator, dump water from the pool and fill the pool with fresh water until the salt levels are reduced to the optimum 6000ppm.

### The STATUS DISPLAY constantly indicates 'PRIMING CELL'. What should I do?

Check cell connection to the junction box on the rear of the control unit.  
Check the filter pump is turned on and that water is flowing past the cell.  
Check valves are open (if fitted).  
Check water level of pool.  
Check for skimmer box blockage.  
Check for air in filter pump.  
Check filter is clean.

### The CHLORINE OUTPUT is LOW or NIL, what should I do?

Check that the chlorine output has not been turned down.  
Check cell connection to junction box underneath control unit.  
Check filter pump is working.  
Check that the salt level is 6000ppm.  
Check the water balance.

## INSTALLATION

Position the chlorinator power pack at least 1m above ground level and at least 2m from the pool edge. Protect the unit from direct weather and sun. If supply cord is damaged, it shall be replaced by the manufacturer or its service agent or similarly qualified person in order to avoid a hazard.

The Pristine Cell must be fitted in the return to pool line after and above the filter and should a pool heater be used the cell must be fitted after the heater. The Pristine Cell can be positioned horizontally or vertically; however the preferred method is horizontally (as illustrated).

The cell lead connects directly to the junction box on the back of the chlorinator power pack. Make sure that the wires are colour matched correctly and that the connections are tight.

The Pristine chlorinator must be connected to the correct supply voltage as indicated on the rear of the unit. CAUTION : CHECK THIS VOLTAGE CAREFULLY

Add sufficient salt to give a salinity reading of 6000ppm (approximately 30kg of salt per 5000l). Start with less and test before you add additional salt.

## INSTALLATION OVERVIEW

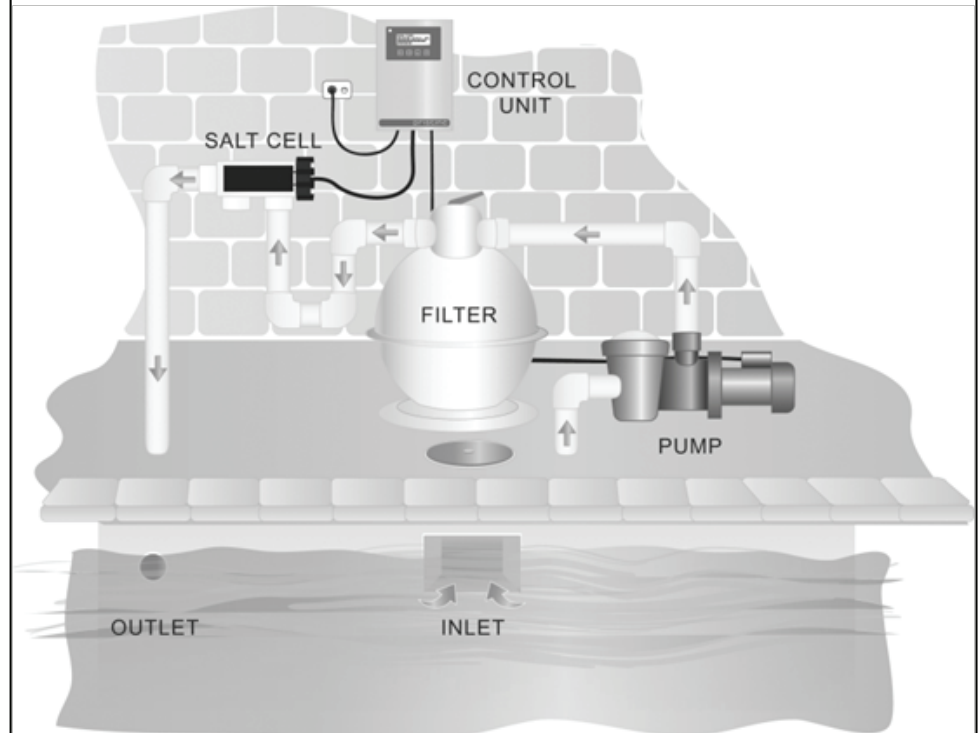

## IDEAL WATER QUALITY

<b>SALINITY</b>	6000ppm (6 grams per litre)
<b>pH</b>	6.8 to 7.4 (for fibreglass, vinyl lined and epoxy painted pools) 7.2 TO 7.8 (for other pool finishes)
<b>ALKALINITY</b>	80 to 150ppm
<b>STABILIZER</b>	40 to 60ppm
<b>FREE CHLORINE</b>	1.0 to 3.0ppm

## OPERATION

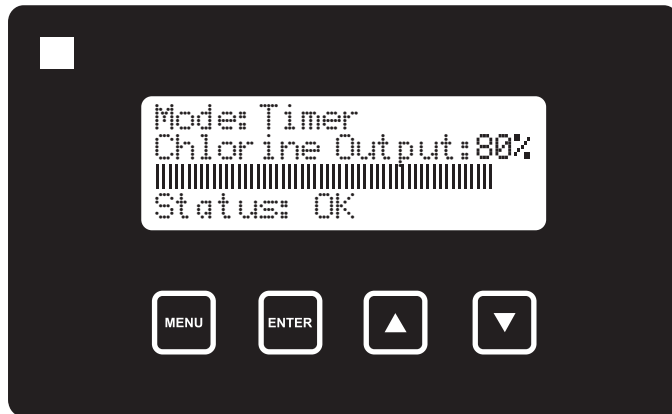

**[MENU]** The [MENU] button is used to enter or exit the MAIN MENU or to exit the sub-menus.

**[ENTER]** The [ENTER] button is used to enter a selected menu, confirm a setting, or to toggle between modes of operation.

**[▲]:** The [▲] button is used to navigate menus and modify settings.

**[▼]:** The [▼] button is used to navigate menus and modify settings.

In the case of a mains power disruption, the Pristine chlorinator will retain all user settings indefinitely. The internal clock can maintain the correct time for approximately two weeks without connection to the mains power for re-charging. Simply re-enter the time if the unit is disconnected from the power for extended periods. See page 11 for details.

## HELPFUL HINTS

When the pool water is tested accurately and all the recommended levels are met you should be able to set the Chlorine Production Output to 100%. (Winter time you may only reach 70-80% because the water is cold) This means the maximum amount of chlorine the chlorinator is rated at is being produced.

Production levels may decrease over the years as the coating on the electrode wears. At this stage you may have to run the Pristine Chlorinator for longer periods to keep the water at the optimum chlorine level.

If the water is cloudy or the chlorine residual tests are low, then the chlorine being produced is being lost due to high demand, or the Chlorine Production Output settings may not be set to the maximum position.

To reduce the chlorine demand, check the pH reading and check for low or high stabilizer reading. If all tests are correct, then shock treatment with an oxidiser agent is advised.

Super chlorination is not usually necessary if the pool water balance is maintained at correct levels. Sometimes however, super chlorination can be useful when there are high bather loads.

If there are a lot of air bubbles passing through the cell housing, it may not be possible to achieve 100% chlorine production, as the air bubbles can interfere with water contacting the cell electrode.



## HOW DOES THE SELF CLEANING Pristine CELL WORK?

To describe the operation simply, the Pristine Chlorinator controls the forward direction of the cell for a period of 12 hours.

It then stops for a short period before slowly ramping up to the set power level in the reverse direction for a period of 12 hours. This reversing process is repeated continually and assists greatly in reducing calcium build-up in the cell.

When the Pristine Chlorinator is reversing the direction of the cell, all "Menu Operations" become inactive during the changeover period.

The Pristine Chlorinator also monitors the power passed through the cell when in forward or reverse direction. The "Dynamic Cell Balancing" technology constantly tracks the power output to further assist in eliminating scale build up and uneven cell wear.

Therefore, the cell is almost maintenance free.

Heavy bathing leads and excess suntan lotion can coat the cell and affect chlorine production over an extended period and the cell may need a light acid wash every six months.

CLEANING MIXTURE: 1 part pool acid to 10 parts water

NOTE: Excess acid will damage the cell.

## HOW DO I MAINTAIN THE CELL?

If at any time you find it necessary to clean the cell please follow the following steps:

1. Create a "cleaning mixture" in a container consisting of 1 part pool acid to 10 parts water. DO NOT USE MORE ACID.
2. Switch off the chlorinator power and unplug from power outlet.
3. Remove the cell from the housing by unscrewing the cell cap.
4. Place cell into container of cleaning mixture and leave for a few minutes to dissolve scale build up. DO NOT SCRATCH OR SCRUB - This will damage the coating and void the warranty.
5. If the scale build up does not dissolve after approximately 10 minutes, create a new mixture and repeat the process.
6. Replace cell in housing and screw cap back on, ensuring that it has been fitted securely.
7. Plug in Pristine Chlorinator and switch power on.

## MAIN OPERATING SCREEN

### MODE

Displays the current MODE of operation from the list of modes on the following page.

Mode: Timer  
Chlorine Output: 80%  
Status: OK

### Chlorine Output

Displays the current level of chlorine production as both a percentage and as a bar graph to an accuracy of 1%.

To increase chlorine output press the [▲] button.

To decrease chlorine output press the [▼] button.

### STATUS

Display the system status.

#### OK

Current condition is normal

#### LOW SALT

Indicates when a low salt condition is present

#### SALT HIGH

Indicates when a high salt condition is present

#### PRIMING CELL

Chlorinator is waiting for pump to start and deliver water to the cell.

#### PUMP FAIL

Cell did not become primed in the allotted time (only occurs if PUMP PROTECTION is enabled).

### CHANGING MODES

There are two ways to change the MODE. You can cycle through OFF, ON, and TIMER modes via the MAIN OPERATION SCREEN by pressing the [ENTER] button. Each time the [ENTER] button is pressed the MODE is advanced to the next and then repeats. Alternatively, you can change the MODE via the MAIN MENU, and in so doing, will be able to invoke the SUPERCHLORINATE and SPA modes which are not accessible from the main operating screen.

To enter the MAIN MENU press the [MENU] button.

Use the [▲] and [▼] buttons to navigate the MAIN MENU until the arrow indicates that you have reached MODE SELECT. Now press the [ENTER] button.

Use the [▲] and [▼] buttons to select the desired MODE of operation.

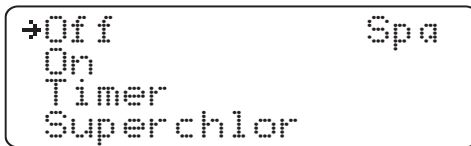

- Off** No operation
- On** Operates continuously at user defined output power level
- Timer** Operates in relation to user defined 'Timer Settings'
- SuperChlor** 24 hours operation at highest possible output up to 100%
- Spa** Operates with an output of 10% indefinitely

Press the [MENU] button to select the desired mode and return to the MAIN MENU.

Press the [MENU] button once more to exit the MAIN MENU and return to the MAIN OPERATING SCREEN.

### SETTING THE CHLORINE OUTPUT LEVEL

There are two ways to set the CHLORINE PUTPUT level.

You can increase or decrease the CHLORINE OUTPUT level via the MAIN OPERATING SCREEN using the [▲] and [▼] buttons.

Alternatively, you can set the CHLORINE OUTPUT level via the MAIN MENU.

Enter the MAIN MENU by pressing the [MENU] button. Use the [▲] and [▼] buttons to navigate the MAIN MENU until the arrow indicates that you have reached CHLORINE OUTPUT. Press the [ENTER] button to enter the settings.

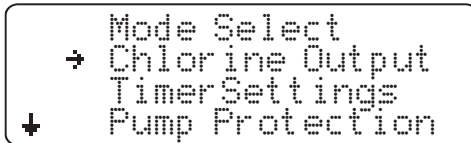

Increase or decrease the CHLORINE OUTPUT using the [▲] and [▼] buttons.



Press the [MENU] button to save your changes and return to the MAIN MENU.

Press the [MENU] button once more to exit the MAIN MENU and return to the MAIN OPERATING SCREEN.

Press the [MENU] button once more to exit the MAIN MENU and return to the MAIN OPERATING SCREEN.

### SYSTEM INFO

Enter the MAIN MENU by pressing the [MENU] button.

Use the [▲] and [▼] buttons to navigate the MAIN MENU until the arrow indicates that you have reached SYSTEM INFO. Press the [ENTER] button to enter the SYSTEM INFO display screen.

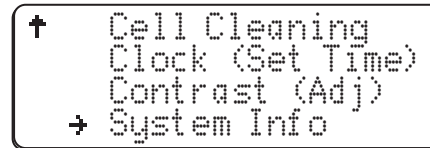

The SYSTEM INFO screen displays system information which is mainly of use to the manufacturer and its service agents.

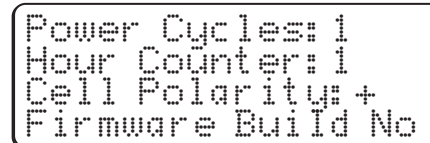

**POWER CYCLES** The number of times the Chlorinator has had power removed and applied.

**HOURLY COUNTER** The total number of hours the Chlorinator has operated.

**CELL POLARITY** The polarity at which the electrolytic cell is currently working in. '+' is forward and '-' is reverse.

**FIRMWARE BUILD NO.** Denotes the firmware revision installed into the chlorinator.

To exit the SYSTEM INFO display screen and return to the MAIN MENU press the [MENU] button.

### SETTING THE TIME

Enter the MAIN MENU by pressing the [MENU] button.

Use the [▲] and [▼] buttons to navigate the menu until the arrow indicates that you have reached SET TIME. Press the [ENTER] button to enter into the settings.



Use the [▲] and [▼] buttons to set the HOURS. *Be aware that the system uses a 24 hour clock!*

Press the [ENTER] button to confirm the HOURS setting. The arrow pointer will now move automatically to the next line where you will be prompted to set the MINUTES using the [▲] and [▼] buttons once more.

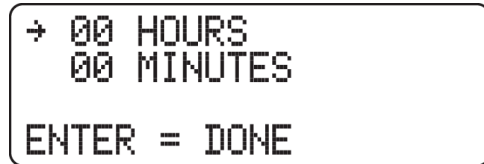

Press the [ENTER] button to confirm the MINUTES setting. You will now be automatically returned to the MAIN MENU.

Press the [MENU] button once more to exit the MAIN MENU and return to the MAIN OPERATING SCREEN.

### ADJUSTING THE LCD CONTRAST

Enter the MAIN MENU by pressing the [MENU] button.

Use the [▲] and [▼] buttons to navigate the MAIN MENU until the arrow indicates that you have reached ADJUST CONTRAST. Press the [ENTER] button to enter into the settings.

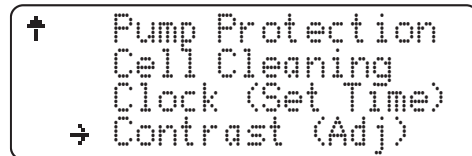

Use the [▲] button to increase the contrast level, and the [▼] button to decrease the contrast level.

Once you have set the CONTRAST to a suitable level, press the [MENU] button to save your changes and return to the MAIN MENU.

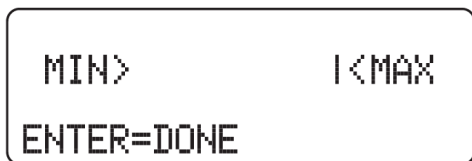

### SETTING THE TIMER

Enter the MAIN MENU by pressing the [MENU] button.

Use the [▲] and [▼] buttons to navigate the menu until the arrow indicates that you have reached TIMER SETTINGS. Press the [ENTER] button to enter into the settings.

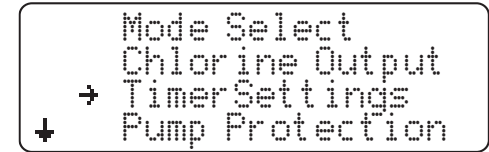

The TIMER SETTINGS can be programmed to turn the chlorinator ON or OFF in one hour segments over the course of a 24 hour day.

#### CLEAR SEGMENT = OFF

The chlorinator will NOT operate for that whole hour

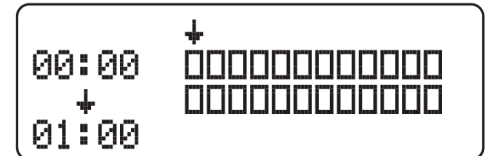

#### FILLED SEGMENT = ON

The chlorinator will operate for that whole hour

Use the [▲] and [▼] buttons to move the pointer to the desired segment.

Press the [ENTER] button to toggle the corresponding segment either ON or OFF.

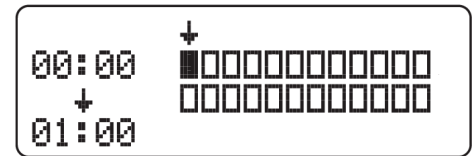

To the left of the screen, the time period relating to the segment indicated by the pointer is displayed.

If you select the first segment to be ON (as shown in the above example) the chlorinator will turn on at 12am and switch off at 1am.

You can turn ON or OFF as many one hour segments as you wish.

Press the [MENU] button to save changes and return to the MAIN MENU.

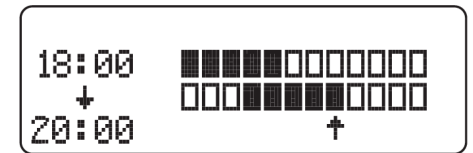

Press the [MENU] button once more to exit the MAIN MENU and return to the MAIN OPERATING SCREEN.

The example above shows the chlorinator will operate from 12am-5am and 3pm-8pm

## PUMP PROTECTION

Enter the MAIN MENU by pressing the [MENU] button.

Use the [▲] and [▼] buttons to navigate the MAIN MENU until the arrow indicates that you have reached PUMP PROTECTION. Press the [ENTER] button to enter into the settings.

```
Mode Select
Chlorine Output
Timer Settings
+ → Pump Protection
```

Press the [▲] and [▼] button to toggle the PUMP PROTECTION feature ON or OFF.

```
→ On
Fail After 10 min
ENTER = DONE
```

Press the [ENTER] button to save the selection made and the arrow pointer will move to the next line.

Press the [▲] and [▼] buttons to set the PUMP PROTECTION timeout value to your desired setting. This value can range between 1 and 10 minutes.

Press the [ENTER] button to save your changes and return to the MAIN MENU.

Press the [MENU] button once more to exit the MAIN MENU and return to the MAIN OPERATING SCREEN.

*PUMP PROTECTION when activated provides additional protection to the pump in the case of a blockage or plumbing fault. PUMP PROTECTION will prevent the pump from running dry for prolonged periods of time which may cause undue wear or damage to the pumps seals. One a PUMP FAIL condition has arisen due to a blockage or plumbing fault, the chlorinator will cease to operate for a period of one hour. If after an hour, the chlorinator is still scheduled to run, it will start up again in the hope that remedial action has been taken, or the condition which caused the PUMP FAIL condition has cleared on its own accord.*

## CELL CLEANING

Enter the MAIN MENU by pressing the [MENU] button.

Use the [▲] and [▼] buttons to navigate the menu until the arrow indicates that you have reached SET TIME. Press the [ENTER] button to enter into the settings.

```
↑ Chlorine Output
Timer Settings
Pump Protection
↓ → Cell Cleaning
```

Use the [▲] and [▼] buttons to set the number of hours (between four and twelve hours) you wish to clean the cell.

```
Clean Cell Every:
→ 12 Hours
```

### HOW DOES THE NUMBER OF HOURS I SELECT CLEAN MY CELL?

The Pristine Cell is constructed of special material that is coated on both sides; this enables the cell to work in forward or reverse. Should you leave the recommended default of 12 hours, the cell will go forward for 12 hours of operation and then in reverse for the next 12 hours of operation.

Every time the cell changes the direction of operation, this assists in cleaning the calcium from the plates.

### HOW MANY HOURS SHOULD I SELECT?

For most swimming pools 12 hours will be efficient for keeping the cell clean. The cleaning process generally happens over an hour after the cell changes direction. If you watch the cell during the beginning of a new cycle and it doesn't appear to be cleaning all of the calcium off, you may need to reduce the number of hours that the cell cleans.

**IMPORTANT: If you must reduce the time between cycles, test and measure by one hour at a time. The greater the time difference between cell cycles, the longer your cell will last.**

### CLEANING TIP

Every few months a self cleaning cell still requires cleaning in acid, however you may like to reduce the time between cycles every few months to 4 hours for one to two days to help lift built up calcium and then increase the time difference to your standard setting once clean.

This method could help reduce manual cleaning to a few times per year.