

**READ THE FOLLOWING WARNINGS BEFORE PROCEEDING TO INSTALL OR DO MAINTENANCE WORK ON THE PUMP.**  
**WARNING: PRODUCT INTENDED FOR PROFESSIONAL USE, BY SKILLED PEOPLE.**  
**WARNING: MAINTENANCE WORK ON THE PUMP MUST ONLY BE CARRIED OUT BY AUTHORISED, TRAINED PERSONNEL**

- Install the pump in a place where the temperature does not exceed 40°C and the relative humidity is below 90%. This pump has a protection level of IP65 and so can be installed outdoors. This pump must never be immersed in liquid. To prevent overheating do not install the pump in direct sunlight.
  - Check that the power supply voltage fed to the plant is as indicated in the label on the pump.
- WARNING: BEFORE DOING ANY WORK ON THE PUMP, ALWAYS FIRST DISCONNECT THE POWER SUPPLY CABLE.**

- When handling the pump after it has been used to dose chemical products, remember to use protective clothing and gloves and to provide suitable protection for your eyes.
- If you are dosing using pressurised piping, before starting the pump always check that the pressure in the plant does not exceed the maximum working pressure shown on the dosage pump label.

**WARNING:** Before opening the pump (via the back cover) disconnect all the connections as shown in the diagram in Fig.13.

**TECHNICAL CHARACTERISTICS**

Check the pump's main characteristics indicated on the nameplate.

Your pump is one of the family of pumps listed in the table below:

| Model | Pressure<br>bar | Flow Rate<br>L/h | cc / stroke | Strokes / min | Connections<br>(mm) |       | Weight<br>Kg |
|-------|-----------------|------------------|-------------|---------------|---------------------|-------|--------------|
|       |                 |                  |             |               | IN / OUT            | 4 / 6 |              |
| 0505  | 7               | 3                | 0.36        | 140           | 4 / 6               |       | 1,4          |
|       | 5               | 5                | 0.60        |               |                     |       |              |
|       | 2               | 6                | 0.71        |               |                     |       |              |

**OVERALL DIMENSIONS AND DRILLING TEMPLATE**

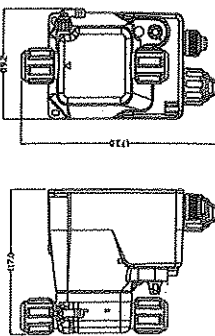

Fig. 4: Overall dimensions of pump

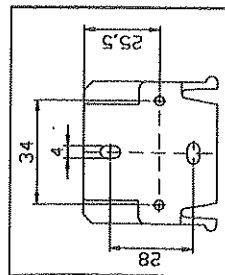
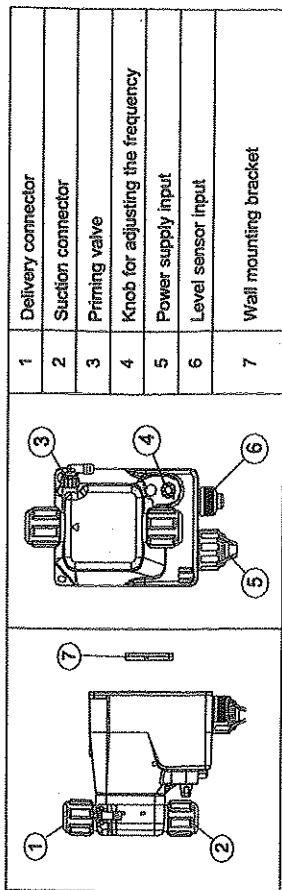

Fig. 5: Bracket drilling template

**COMPOSITION OF THE SYSTEM**



**PACKING CONTENTS**

| OLIMPIA   |
|---|
| Complete pump   |
| Foot filler (Fig. 1)  |
| Injection fitting (Fig. 2)  |
| 4 m of PVC hose (transparent and soft) for suction and for connecting the bleeding valve up for manual priming (Fig. 3) |
| 2 m of PE pipe (opaque and rigid) for connecting the pump's outlet to the injection point (Fig. 3)                      |
| Anchors for securing the pump.  |
| Support for wall mounting   |
| Instruction Manual  |
| Power cable (2 m) with clamp and cable-holder   |

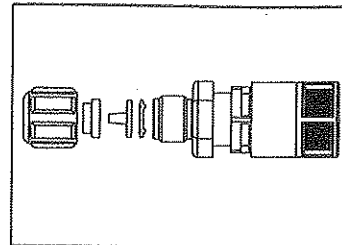

Fig. 1: WT Foot filler

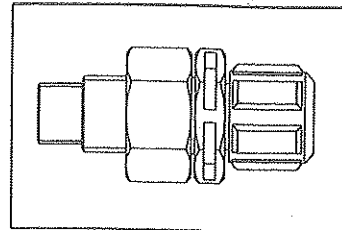

Fig. 2: WT Injection fitting

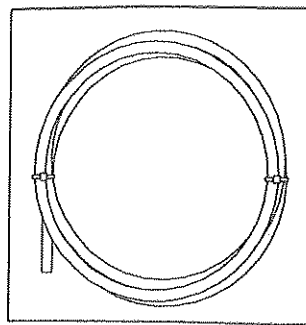

Fig. 3: Hoses (suction, delivery, bleeding)

SETTING AND OPERATION

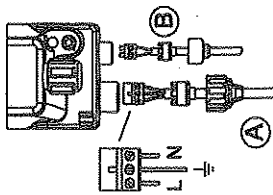

Fig. 3: Connection Diagram

Input A = power supply  
Input B = Level



**WARNING:** The level (LEVEL) contact **ONLY** accepts voltage-free signals.

OPERATION

Once all installation operations have been completed you are ready to start the pump.

Priming

- Connect the suction hose to the suction fitting on the pump.
- Connect the other end of the suction hose to the foot filter.
- Immerse the foot filter inside the product jerry can.
- Connect the drain hose to the fitting and put the other end into the tank, above the maximum liquid level.
- Start the pump at top speed, open the priming fitting by turning the knob anticlockwise and wait until liquid flows out of the hose connected to it.
- Once you are sure that the pump is completely full of liquid, close the fitting and the pump will start dosing.

Adjusting the flow rate

The flow rate can be varied by adjusting the frequency regulating knob on the front of the pump. Pump operation is stopped by turning the knob fully anticlockwise.

Indication LED

The LED on the front of the pump indicates its operating status:

- Flashing in time with the magnet - Normal operation.
- Flashing slowly without dosing - Functional stop.
- Flashing quickly without dosing - Level alarm.
- LED switched off - power supply disconnected or insufficient voltage (< 90 Vac).

PLUMBING CONNECTIONS

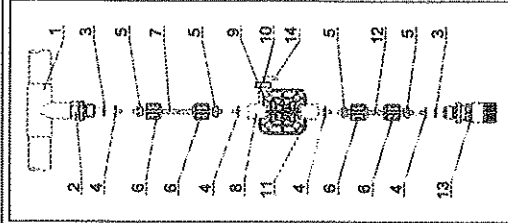

Fig. 6: Connection example

- 1) Injection point
- 2) Injection fitting
- 3) PE gasket
- 4) Washer holder
- 5) Pipe clamp
- 6) Ring nut
- 7) Delivery pipe (opaque and rigid)
- 8) Delivery fitting
- 9) Pump casing
- 10) Manual bleeding valve
- 11) Suction coupling
- 12) Suction hose (soft and transparent)
- 13) Foot filter
- 14) Drain hose (soft and transparent)

RECOMMENDED INSTALLATION LAYOUTS

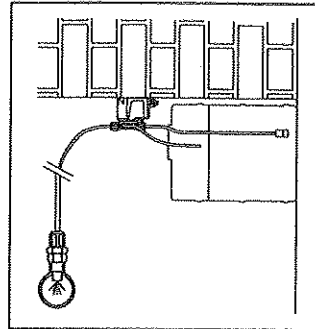

Fig. 7: Wall mounted installation

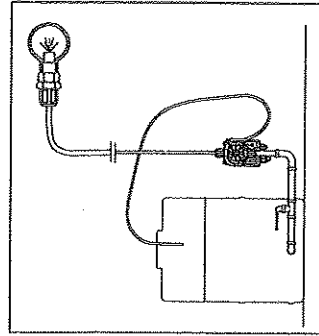

Fig. 8: Flooded suction mounting